

Packaged Air Conditioner

Application

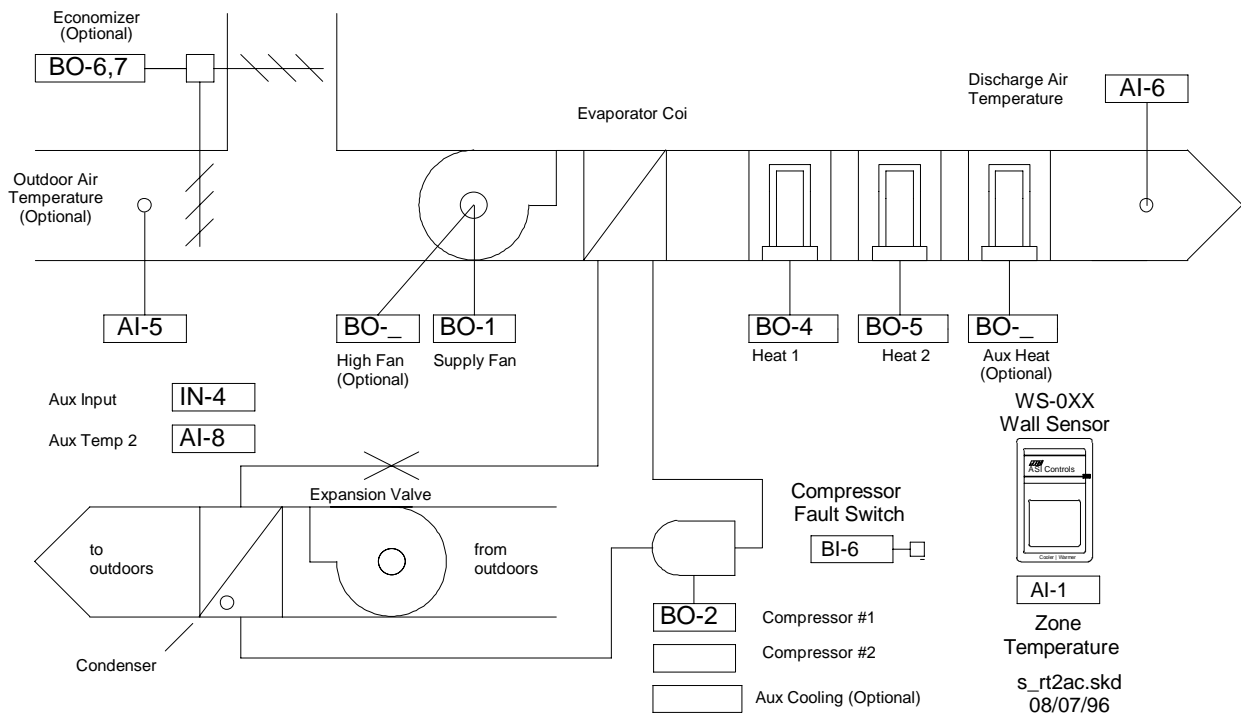

The ASIC/1-8355 Packaged Air Conditioner controller has 4 air conditioner personalities for up to 2 stages of heating and two stages of cooling:

- Personality 1, 1 Stage Air Conditioner with 1 Stage Heating
- Personality 2, 1 Stage Air Conditioner with 2 Stage Heating
- Personality 3, 2 Stage Air Conditioner with 1 Stage Heating
- Personality 4, 2 Stage Air Conditioner with 2 Stage Heating

Optionally, an economizer may be controlled on outside air temperature. Discharge Air Temperature Low Limit control may also be implemented.

Output Assignments (AC)

Personality	Stages	BO-1	BO-2	BO-3	BO-4	BO-5*	BO-6*
1	1 CLG,1 HTG	SFAN	CLG1	-	HTG1		
2	1 CLG,2 HTG	SFAN	CLG1	-	HTG1	HTG2*	
2	1 CLG,2 HTG, AuxHTG	SFAN	CLG1	-	HTG1	HTG2*	AuxHTG*
3	2 CLG,1 HTG	SFAN	CLG1	CLG2	HTG1		
3	2 CLG, 1 HTG, AuxCLG	SFAN	CLG1	CLG2	HTG1	AuxCLG*	
4	2 CLG,2 HTG	SFAN	CLG1	CLG2	HTG1	HTG2*	

*User Assignable Outputs.

Personality 1, 1 AC with 1 HTG

Single Stage Air Conditioner. In the Cooling Mode, Compressor 1 is on a fraction of the Compressor Duty Cycle Time based on Cooling Requirement. The Compressor 1 On Time goes from 0 to 100% of the Compressor Duty Cycle Time as Cooling Requirement goes from 0 to 100%.

Single Stage Heating. In Heating Mode, Heat 1 is on a fraction of the Heating Base Time based on Heating Requirement. The Heat 1 On Time goes from 0 to 100% of the Heating Base Time as the Heating Requirement goes from 0 to 100%

Personality 2, 1 AC with 2 HTG

Single Stage Air Conditioner. In the Cooling Mode, Compressor 1 is on a fraction of the Compressor Duty Cycle Time based on Cooling Requirement. The Compressor 1 On Time goes from 0 to 100% of the Compressor Duty Cycle Time as Cooling Requirement goes from 0 to 100%.

Two Stage Heating. In Heating Mode, Heat 1 and 2 are on a fraction of the Heating Base Time based on Heating Requirement. The Heat 1 On Time goes from 0 to 100% of the Heating Base Time as the Heating Requirement goes from 0 to 50% The Heat 2 On Time goes from 0 to 100% of the Heating Base Time as the Heating Requirement goes from 50% to 100%. Heat 1 remains on so long as Heat 2 is on.

Personality 3, 2 AC with 1 HTG

Two Stage Air Conditioner. In the Cooling Mode, Compressor 1 and 2 are on a fraction of the Compressor Duty Cycle Time based on Cooling Requirement. The Compressor 1 On Time goes from 0 to 100% of the Compressor Duty Cycle Time as Cooling Requirement goes from 0 to 50%. The Compressor 2 On Time goes from 0 to 100% of the Compressor Duty Cycle Time as Cooling Requirement goes from 50% to 100%. Compressor 1 remains on so long as Compressor 2 is on.

Single Stage Heating. In Heating Mode, Heat 1 is on a fraction of the Heating Base Time based on Heating Requirement. The Heat 1 On Time goes from 0 to 100% of the Heating Base Time as the Heating Requirement goes from 0 to 100%

Personality 4, 2 AC with 2 HTG

Two Stage Air Conditioner. In the Cooling Mode, Compressor 1 and 2 are on a fraction of the Compressor Duty Cycle Time based on Cooling Requirement. The Compressor 1 On Time goes from 0 to 100% of the Compressor Duty Cycle Time as Cooling Requirement goes from 0 to 50%. The Compressor 2 On Time goes from 0 to 100% of the Compressor Duty Cycle Time as Cooling Requirement goes from 50% to 100%. Compressor 1 remains on so long as Compressor 2 is on.

Two Stage Heating. In Heating Mode, Heat 1 and 2 are on a fraction of the Heating Base Time based on Heating Requirement. The Heat 1 On Time goes from 0 to 100% of the Heating Base Time as the Heating Requirement goes from 0 to 50%. The Heat 2 On Time goes from 0 to 100% of the Heating Base Time as the Heating Requirement goes from 50% to 100%. Heat 1 remains on so long as Heat 2 is on.

Optional Auxiliary Heating

Optional Auxiliary Heating may be used as an additional stage of heating. If Auxiliary Heating Enable is set, the auxiliary heating output goes on whenever the controller is in the heating mode, the Heating Requirement is 100 % and the zone temperature is less than the active heating setpoint by an Auxiliary Temperature Offset for an Auxiliary Delay Time. The Auxiliary Heating goes off when the active heating setpoint is reached and the Heating Requirement is less than 100 % by the Auxiliary Hysteresis.

Optional Auxiliary Cooling

Optional Auxiliary Cooling may be used as an additional stage of cooling. If Auxiliary Cooling Enable is set, the auxiliary cooling output goes on whenever the controller is in the cooling mode, the Cooling Requirement is 100 % and the zone temperature is greater than the active cooling setpoint by an Auxiliary Temperature Offset for an Auxiliary Delay Time. The Auxiliary Cooling goes off when the active cooling setpoint is reached and the Cooling Requirement is less than 100 % by the Auxiliary Hysteresis.

Inputs

The ASIC/1-8355 controller has specific inputs for zone temperature, optional water loop temperature, optional discharge air temperature, optional outdoor air temperature, and optional occupancy sensor. The standard input types are set at the factory. Inputs that are not required for the sequence may be used for monitoring, and may be scaled to read various analog sensors.

Wall Sensor Connections

Zone temperature sensor is on input 1. Typically, the zone temperature on the WS-0XX, or WT-0XX wall sensor, is connected to the controller using a SCP-XXX sensor cable. Alternately, a zone or return air temperature sensor may be attached on the input blade, IN1, and input common, COM.

Note: If there is no zone temperature sensor, then the zone sensor input is in fault, all outputs are off, and it does not try to control.

January 1999

The afterhours push-button on the WT-0XX or WS-0XX wall sensor if used, is always on input 2. If Afterhours Enable is Yes, then shorting the input to zero will initiate afterhours override mode for an Afterhours Time Allowed.

Input 2 may also be used for the user adjust switch on the WT-0XX Wall Sensor. When User Adjust Enable is set and input 2 is configured for user adjust switch, the zone temperature setpoint may be adjusted up or down by the User Adjust Setpoint, based on the condition of Input 2.

Input 3 is used for Interlock and may also be used for variable user adjust with the WS-0XX wall sensor. When User Adjust Enable is set and input 3 is configured for Variable User adjust, 10 to 30 kohm, the zone temperature setpoint may be adjusted up or down by the User Adjust Setpoint, based on the condition of input 3.

Discharge Air Temperature

An optional Discharge Air Temperature sensor, TS-D (duct), may be placed on input 6, for temperature monitoring or optional discharge air temperature control. The temperature sensor uses the factory provided 1.82-kohm pull-up resistor, R20.

The Discharge Air Temperature is used to monitor the supply air temperature. If the discharge air temperature falls below the DAT Low Limit SP, then a low DAT alarm is set. If the discharge air temperature rises above the DAT High Limit SP, then a High DAT alarm is set. Control action for DAT Alarms is discussed below.

Compressor Fault Switch

An optional Normally Open Compressor Fault switch may be placed across the Discharge air sensor on Input 6. Optionally, if any fault occurs in the compressor, the switch will close and the unit will shut down. Up to 3 restarts may be attempted after a restart delay. Control action for Compressor Fault and Lockout Alarms is discussed below.

Water Loop Temperature

An optional Water Loop Temperature sensor, TS-I (insertion) or TS-S (strap-on), on input 7 may be used, to determine if the condenser water loop is within design operating conditions. If outside High or Low Alarm Setpoints, it will set a high or low water loop alarm and optionally disable the compressor. The temperature sensor uses the factory provided 1.82-kohm pull-up resistor, R21. Control action for Water Loop Temperature Alarms is discussed below.

Proof of Fan Switch

An Optional Proof of Fan Switch may be across Input 7 (Water loop) which opens on proof of fan. If Proof of Fan Enable is Yes, the switch is examined whenever the fan, or high fan is on, or in Heating with Gas Heat Enable = Yes. The Proof of Fan Switch is for information only. No actions result from proof of fan alarm. (FW355A 1.9..)

Outdoor Air Temperature

An optional Outdoor Air Temperature sensor, TS-O, may be placed on input 5. The outdoor sensor can provide for temperature monitoring, economizer control, and optional OAT Heating or Cooling Lockout control. The temperature sensor requires the *addition* of a 1.82-kohm pull-up resistor, R19.

If the outdoor air temperature is to be broadcast to the unit by an ASIC/2-7040, then the pull-up resistor and an external 3.32 kohm resistor is required to give a nominal value (74 °F) and to prevent the input from going into fault.

Occupancy Sensor/ Auxiliary Sensor

An optional occupancy sensor, MOT Series, or two-position switch from an occupancy sensing device may be used on input 8 to change the control state from occupied to unoccupied.

An optional Auxiliary Temperature sensor, TS Series, may be placed on input 8 for temperature monitoring. The temperature sensor uses the factory provided 1.82-kohm pull-up resistor, R22. When a two-position occupancy switch is used in combination with a temperature sensor, then the temperature sensor is not read when the contacts are closed when signaling unoccupied.

An Auxiliary Temperature sensor, TS Series, may not be used with the MOT Series Sensor. The use of the occupancy sensor is discussed in APB-311, ASIC/1 Occupancy Sensor.

Auxiliary Input

Input 4, is available for monitoring of temperature, TS, humidity, RH, Amperage or other voltage transducer. The 3-kohm thermistor temperature sensor requires the *addition* of a 1.82 kohm pull-up resistor, R18.

Active sensors with outputs in the 0 to 5 Vdc range do not require a pull-up resistor and may be read as raw inputs.

Control Mode

The controller determines the Control Mode, Heating, Deadband, or Cooling by comparing the zone temperature to the Active Heating Temperature Setpoint and Active Cooling Temperature Setpoint.

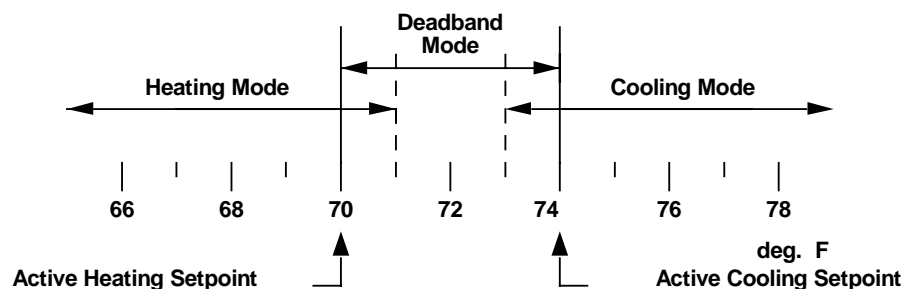

The controller enters the Cooling Control Mode when the zone temperature equals or is greater than the Active Cooling Temperature Setpoint. The control reenters the Deadband mode, when the zone temperature is 1 °F below the Active Cooling Temperature Setpoint and the calculated Cooling Requirement is equal to zero.

The control enters the heating mode when the zone temperature is equal to or less than the Active Heating Temperature Setpoint. The control reenters the Deadband mode when the zone temperature is 1 °F greater than the Active Heating Temperature Setpoint and the calculated Heating Requirement is equal to zero.

Active Temperature Setpoints

The controller maintains the zone temperature between Active Cooling and Heating Temperature Setpoints. The Active Cooling and Heating Temperature Setpoints are based on Control State, the Active User Adjust based on the position of the Slide Switch or Variable User Adjust, and the Active Demand Limit Reset.

If User Adjust Enable is yes, the Active Temperature Setpoints may be modified either by the User Adjust Switch on a WT-0XX wall sensor, or by the variable user adjust potentiometer on a WS-0XX wall sensor depending on the input configuration. The Active Cooling and Heating Temperature Setpoints are adjusted up or down a fraction of the User Adjust Setpoint depending on the user adjust switch or potentiometer setting..

If the Active Demand Level is non-zero, the Active Temperature Setpoints are also modified by a fraction of the Demand Reset Range [Default 6] as the Active Demand Level goes from 0 to 6. The Active Cooling Temperature Setpoint is reset upwards and the Active Heating Temperature Setpoint is reset downwards.

Cooling and Heating Requirement

In Deadband Control Mode, the Heating and Cooling Requirements are zero.

In the Cooling or Heating Control Mode, the Cooling or Heating Requirement is calculated using a PI control loop.

The change in heating or cooling requirement is calculated every 30 seconds.

In heating: Error = Active HTG SP - Zone Temp

Δ Error = Previous Zone Temp - Zone Temp

or in cooling: Error = Zone Temp - Active CLG SP

Δ Error = Zone Temp - Previous Zone Temp.

Δ Requirement = (100%/ThrottleRange)*[Error*(CalcTime/Int Time) + Δ Error]

The factory setting for throttle range is 4.0 degrees, and for integral time is 2.5 minutes.

Cooling Mode

When in Cooling control mode, the controller energizes the available compressor stages for a fraction of the Compressor Duty Cycle Time based on the Cooling Requirement. The operation of the cooling outputs is discussed in more detail below.

Deadband Mode

When in Deadband Control mode, the controller turns off the compressors and available heat stages.

Heating Mode

When in Heating control mode, the controller energizes the available heating stages for a fraction of the Heat Base Time based on the Heating Requirement. The operation of the heating outputs is discussed in more detail below.

Cooling and Heating Requirement (FW355B)

A special firmware version ASIC/1-8355-S (FW355B) has been developed which controls like a proportional thermostat. The temperature control is based on the offset from the Active Temperature Control Setpoint.

January 1999

In Deadband Control Mode, the Heating and Cooling Requirements are zero.

In the Cooling or Heating Control Mode, the Cooling or Heating Requirement is calculated as follows:

When the offset is equal to the Throttle Range [Default 1.0], then the heating or cooling requirement is 100%.

For one stage heating or cooling the heating or cooling requirement is 100%, when the offset is equal to the throttling range and goes to zero when the controller enters Deadband.

For two stages heating or cooling the heating or cooling requirement is 50%, when the offset is equal to the throttling range/2 and goes to zero when the controller enters Deadband.

For two stage heating or cooling the heating or cooling requirement is 100%, when the offset is equal to the throttling range and returns to 50% when the offset is zero.

Control State

The Control State determines which Cooling and Heating Temperature Setpoints are used for zone temperature control. Four control states are possible: Occupied, Unoccupied, Night Setback, and Morning Ready. If the Clock is not synchronized, the Control State is Occupied by default. Otherwise the Control State is determined by the Daily Event Schedule unless this has been disabled.

The Control State may be overridden via a message broadcast over the communication bus from software or an ASIC/2-7040 controller. The Control State may be returned to OCC from NSB or Unoccupied, when the Afterhours Enable is yes and the push-button on the Wall Sensor is pushed. A MOT Series Occupancy Sensor or two-position switch on input 8 may also override the Controller State to Unoccupied from Occupied.

Morning Ready (MRDY) State

Morning Ready is meant as a prelude to Occupied state, to ready the building for daily use. For Morning Ready, the control sequence operates at full-capacity heating or cooling until the zone temperature is moved into the Deadband region. The Occupied Temperature Setpoints are used in Morning Ready.

Control Features

Emergency Modes

Two emergency modes, Emergency 1, and Emergency 2, are overrides that are received over the communication line and remain in effect until cleared over the communication line. Emergency modes are maintained through loss of power.

While in Emergency 1 state the controller immediately turns ON the fan, turns ON the lighting output, and turns OFF any other outputs (including electric heat). No other state may be entered until Emergency 1 has been cleared via the communications line.

If in Emergency 2, no other state except Emergency 1 may be entered until Emergency 2 has been cleared via the communications line. While in Emergency 2 state the controller immediately turns OFF the fan, turns ON the lighting output, and turns OFF any other outputs (including electric heat).

Heating and Cooling Lockouts

It is possible to lockout Heating or Cooling either completely or when the outdoor temperature reaches some Outdoor Air Temperature Lockout Setpoint. The heating and cooling calculations and modes function normally even if lockouts are enabled.

If the Lockout Heating is enabled then all heating outputs are locked out when the controller is in the heating mode.

If the OAT Heating Lockout is enabled and the Outdoor Air Temperature on Input 5 is greater than the OAT HTG Lockout Setpoint, then all heating outputs are locked out when the controller is in the heating mode.

If the Lockout Cooling is enabled, then the compressor cooling and auxiliary cooling outputs are locked out when the controller is in the cooling mode.

If the OAT Cooling Lockout is enabled and the Outdoor Air Temperature on Input 5 is less than the OAT CLG Lockout Setpoint, then the compressor cooling and auxiliary cooling outputs are locked out when the controller is in the cooling mode.

Outputs

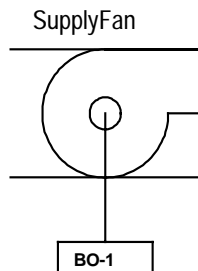

Fan Output

The ASIC/1-8355 has On/Off fan control. The fan is ON whenever there is a call for heating or cooling. In Deadband the fan follows the appropriate state of Intermittent Fan Enable. The Fan is always BO-1.

If Intermittent Fan Enable is Yes in Occupied, or if NSB Intermittent Fan Enable, UNOC Intermittent Fan Enable, or MRDY Intermittent Fan Enable is Yes, then the Fan turns OFF in Deadband after a Fan Wait Time in the respective control states.

If Intermittent Fan Enable is No in Occupied or if NSB Intermittent Fan Enable, UNOC Intermittent Fan Enable, or MRDY Intermittent Fan Enable is No, then Fan is always ON in Deadband in the respective control states.

Demand Limit

If Shed Fan Enable is Yes, then the low and high fans are shed when the Active Demand Level equals or exceeds the Demand Shed Level, or the Demand Rotate Level for the matching Demand Group. The compressor is interlocked to the fan so that the compressor will turn off, if the fan turns off.

Gas Heat Option

For Air Conditioner personalities the gas heat operation is changed. If Gas Heat Enable is Yes, the Fan Output does not come on in the heating mode. If the Fan is on when entering heating it is turned off.^{1, 2}

¹ For FW355A 1.8 and earlier versions for Air Conditioner personalities in the Heating Control Mode or in Deadband entered from heating, if Gas Heat Enable is yes, the fan is left OFF for a Gas Heat Fan On Delay before being turned ON. When the fan is to be turned OFF, the fan remains ON for a Gas Heat Fan Off Delay before being turned OFF.

² For FW355A 1.9 to 2.1 the Fan is Off in Heating Mode, but the heat would not come on. This has been fixed in FW355A 2.2.

Proof of Fan

A Proof of Fan Switch across Input 7 (Water loop) Opens on proof of fan. If Proof of Fan Enable is Yes, the switch is examined whenever the fan, or high fan is on, or in Heating with Gas Heat Enable = Yes. The Proof of Fan Switch is for information only. No actions result from proof of fan alarm. (355A 1.9.,T6,5,bit5)

A Proof of Fan Status is set when proof of fan is established. Proof of Fan Alarm, (Alarm 5 HI) is set when proof of fan fails to be detected after a Proof of Fan Delay, [10s] on start, or if Proof of Fan is lost for a Proof of Fan Delay.

High Speed Fan Option

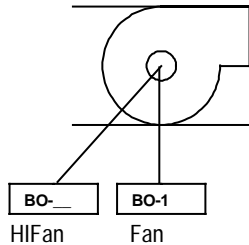

The ASIC/1-8355 has On/Off High Fan control. The high-speed fan may be enabled for cooling mode or heating mode or both. If enabled, and if the zone temperature deviates from the active control setpoint by the High Fan Temperature Offset for at least the High Fan Delay Time, then the high-speed fan output replaces the low-speed fan. When in operation, the high-speed fan behaves identically to the low-speed fan. Control is switched back to the low-speed fan when zone temperature has returned to the active control setpoint for High Fan Delay Time.

In switching between High and Low speeds the output goes off for 1 second before contact. The High Fan Mask must be assigned to the proper output.

Options are provided for Low Speed Only, switching between High and Low, and High Speed Only for both Heating and Cooling Modes based on the status of High Fan Enable and High Fan Only Enable. For modes where the fan runs in Deadband, the selection of High or Low Fan in Deadband depends on whether it was entered from Heating or Cooling.

High Fan Enable	High Fan Only Enable	Selection
No	No	Low Speed Only
Yes	No	Switch High & Low
No	Yes	High Speed Only
Yes	Yes	High Speed Only

Compressor 1 Output

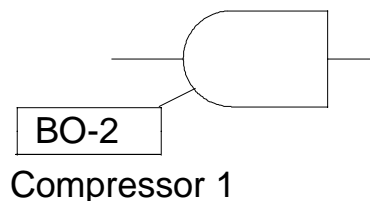

The Compressor 1 Output is used for Cooling 1 for Air Conditioner Sequences.

Compressor 1 is on a fraction of the Compressor Duty Cycle Time based on the Cooling Requirement. If the Compressor Fault alarm appears, the Compressor 1 is turned off immediately, and does not restart until the Minimum Off time elapses.

The operation of Compressor 1 is interlocked to the fan being on. Compressor 1 has a Compressor Minimum On Time and a Minimum Off Time. Compressor 1 is always BO-2.

Single Stage Air Conditioner (Personality 1 & 2): In the Cooling Mode, Compressor 1 is on a fraction of the Compressor Duty Cycle Time based on Cooling Requirement. The Compressor 1 On Time goes from 0 to 100% of the Compressor Duty Cycle Time as Cooling Requirement goes from 0 to 100%.

The compressors can be locked out conditionally based on the following: Cooling Lockout or OAT Cooling Lockout Enable; Emergency Modes, EM1 or EM2; Compressor Fault Lockout Enable, = Yes and Compressor Lockout Alarm; Water

Loop Compressor Disable = Yes and Water Loop Alarm; or DAT Compressor Disable = Yes and DAT Alarm.

The compressors and auxiliary cooling and heating are shed when the Active Demand Level is equal or exceeds the Demand Shed Level or the Demand Rotate Level for the matching Demand Group.

Compressor 2 Output

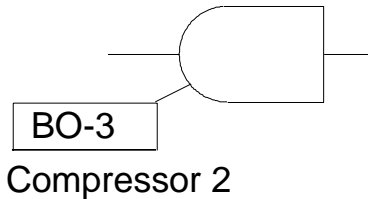

The Compressor 2 Output is used for Cooling 2 for Air Conditioner Sequences. Compressor 2 is on a fraction of the Compressor Duty Cycle Time based on the Cooling Requirement. If the Compressor Fault alarm appears, the Compressor 2 is turned off immediately, and does not restart until the Minimum Off time elapses.

The operation of Compressor 2 is interlocked to the fan being on. Compressor 2 has a Compressor Minimum On Time and a Minimum Off Time. Compressor 2 is always BO-3.

Two Stage Air Conditioner (Personality 2 & 4): In Cooling mode Compressor 1 and 2 are on a fraction of the Compressor Duty Cycle Time based on Cooling Requirement. The Compressor 1 On Time goes from 0 to 100% of the Compressor Duty Cycle Time as Cooling Requirement goes from 0 to 50%. The Compressor 2 On Time goes from 0 to 100% of the Compressor Duty Cycle Time as Cooling Requirement goes from 50% to 100%. Compressor 1 remains on so long as Compressor 2 is on.

Heat 1 Output (AC)

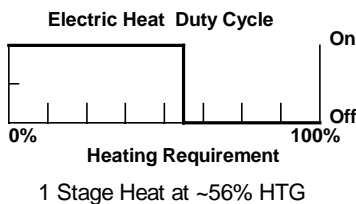

Air conditioning personalities have up to 2 stages of Heating output. The Heat 1 output is always on Output-4. Heat operation is interlocked to the fan being ON, unless Gas Heat Enable is Set.

For a controller with 1 stage of heat (Personality 1 & 3), in the Heating Mode, Heat 1 Output is on a fraction of the Heating Base Time based on Heating Requirement. The Heat 1 On Time goes from 0 to 100% of the Heating Base Time as the Heating Requirement goes from 0 to 100%.

Stage 1 duty cycles in proportion to the Heat Base Time from 0 to 100% as the Heating Requirement goes from 0 to 50%. Stage 2 does not turn ON until stage 1 is on for 100% of the duty cycle time and duty cycles in proportion to the Heat Base Time from 0 to 100% as the Heating Requirement goes from 50% to 100%.

Heat 2 Output (AC)

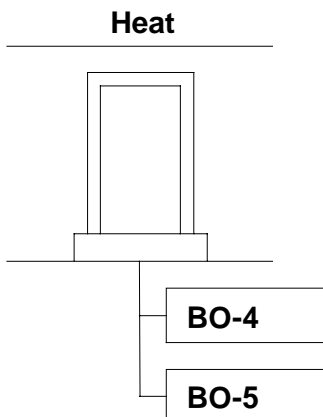

Two Stage Heating. For a controller with 2 stages of heat (Personality 2 & 4), Stage 2 does not turn ON until stage 1 is on for 100%. The Heat 2 Output to be controlled is identified by the Heat 2 Mask, which is typically on Output-5.

In Heating Mode, Heat 1 and 2 are on a fraction of the Heating Base Time based on Heating Requirement. The Heat 1 On Time goes from 0 to 100% of the Heating Base Time as the Heating Requirement goes from 0 to 50%. The Heat 2 On Time goes from 0 to 100% of the Heating Base Time as the Heating Requirement goes from 50% to 100%. Heat 1 remains on so long as Heat 2 is on.

Heat 1, Heat 2 and Auxiliary Heating are shed when the Active Demand Level equals or exceeds the Demand Shed Level or the Demand Rotate Level for the matching Demand Group.

Economizer

On/Off Economizer

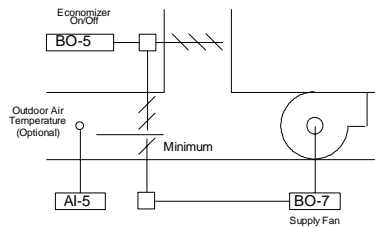

When Economizer Enable is yes and Economizer 3-Position Enable is no, an outdoor damper can be energized when the conditions are suitable for free cooling. The output to be controlled is identified by the Economizer On Off Mask, which is typically on Output-6.

In the Heating mode, or Deadband entered from Heating, and when the fan is On, the Economizer Output is off. In Cooling mode, or in Deadband entered from Cooling, when the fan is On and Economizer Low Limit Temp SP < OAT and OAT < Economizer Temperature SP, then economizer output is On.

When the fan is On and OAT < Economizer Low Limit Temp SP or OAT > Economizer Temperature SP, then Economizer output is off. If the Outdoor Air Temperature Sensor is in fault, then the economizer output is Off.

3-position Economizer

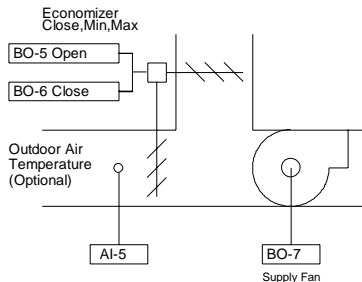

When Economizer Enable is yes and Economizer 3-Position Enable is yes, a tri-state outdoor damper position can be controlled from closed, to minimum, to maximum depending on the conditions for free cooling. The outputs to be controlled are identified by the Economizer Open Mask and the Economizer Close Mask, which are typically Output-6 and Output-7.

The 3-position Economizer position is based on a percentage of the drive time. The Economizer will drive Open or Closed so that the Active Economizer Position is equal to the calculated Active Economizer Position Setpoint.

When the fan is off, the economizer drives to the Economizer Closed Position.

When the fan is On and Economizer Low Limit Temp SP < OAT and OAT < Economizer SP, then Economizer output is at Economizer Maximum Position.

When the fan is On and Economizer OAT < Economizer Low Limit Temp SP or OAT > Economizer SP, then Economizer output is at Economizer Minimum Position.

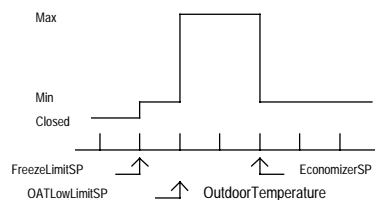

When the fan is On and Economizer OAT < Economizer Freeze Limit SP, then the economizer output is closed. If the Outdoor Air Temperature Sensor is in fault, then the economizer output is closed.

Other Outputs

Auxiliary Cooling Output (Optional)

An optional auxiliary cooling output is provided. If Auxiliary Cooling Enable is yes in the Cooling Mode, and the Cooling Requirement is 100 % and the zone temperature exceeds the active cooling setpoint by an Auxiliary Temperature Offset [Default 2 °F] for a Auxiliary Delay Time [Default: 120 s], then an auxiliary cooling output is energized. The output to be controlled is identified by the Auxiliary Cooling Output Mask. [Default: None].

January 1999

Once energized, the auxiliary cooling output remains on until zone temperature falls below the Active Cooling Setpoint and the cooling requirement falls below 100% by an amount given by the Auxiliary Hysteresis. [Default: 5]

Auxiliary Heating Output (Optional)

An optional Auxiliary Heating Output is provided. If Auxiliary Heating Enable is yes in the Heating Mode, and the Heating Requirement is 100 % and the zone temperature is less than the active Heating setpoint by an Auxiliary Temperature Offset [Default 2 °F] for a Auxiliary Delay Time [Default: 120 s], then an auxiliary Heating output is energized. The output to be controlled is identified by the Auxiliary Heating Output Mask [Default: None].

Once energized, the auxiliary Heating output remains on until zone temperature rises above the Active Heating Setpoint and the Heating requirement falls below 100% by an amount given by the Auxiliary Hysteresis. [Default: 5]

Auxiliary 1, 2 Output (Optional)

The ASIC/1-8355 allows up to 2 outputs for auxiliary outputs that do not follow any schedule. They can be overridden On or Off, and remain in the last state commanded. The outputs to be controlled are identified by the Auxiliary 1 Output Mask and Auxiliary 2 Output Mask [Default: None]. On power reset the Auxiliary 1 & 2 Outputs are off.

Lighting Output (Optional)

Each ASIC/1 has the ability to control lighting. The Lighting schedule will automatically turn the lights on and off. By equipping the ASIC/1 with a WS-0XX wall sensor with push button override, the lights can be operated manually by the occupant during Occupied and Morning Ready States by pressing the button on the side of the zone sensor without affecting HVAC operation.

During Unoccupied and Night Setback States, depressing the push button will return the control to Occupied, and the lights will come on and stay on for Afterhours Time Allowed. During Emergency 1 and Emergency 2, the push-button has no effect.

If an occupancy sensor is used and if Lights Occupied Enable is yes, then the lights are on whenever the Lighting Schedule is On, or the Control State is Occupied.

If Lights Reverse Enable is set³, the output identified by the Lights Output Mask is reversed. When the lights are on, the physical output is OFF. When the lights are off, the physical output is ON. The output status, and Output Status - Lights are unchanged.

Blink Warning: One minute before automatic shut off of lights as designated in the daily event schedule, or at the end of the afterhours override period, the lights will blink off and back on again. Pressing the afterhours button will re-start the lights.

Output Overrides

The ability to override outputs, either by function or by output number, has been provided in the controller for testing purposes only. However these overridden outputs may interfere with normal sequence operation.

³ Added in FW355A 2.0

CAUTION: DO NOT USE output overrides to control the sequence as equipment damage could result. Overrides are for brief testing ONLY.

Alarms

Alarm 1- Zone Temperature

The zone temperature is compared with Active Heating or Cooling Setpoints. If the zone temperature is above the Active Cooling Temperature Setpoint by the Zone Temperature Alarm Range, a High Zone Temperature Alarm is set. If the Zone temperature is below the Active Heating Temperature Setpoint by the Zone Temperature Alarm Range, a Low Zone Temperature Alarm is set. No other actions are taken in response to a zone temperature alarm.

Alarm 2 - DAT

If the discharge air temperature raises above the DAT High Limit Setpoint, a high DAT high limit alarm is set. If the setpoint is 0, this alarm is ignored. If the discharge air temperature falls below the DAT Low Limit Setpoint .a DAT Low Limit alarm is set. If the setpoint is zero, this alarm is ignored. Once a discharge air alarm is set, the temperature must recover by the DAT Alarm Hysteresis before the alarm is cleared.

A DAT Compressor Disable option is included. If the DAT Compressor Disable is Yes, then the Low Discharge Air Temperature Alarm disables the compressor. A High Discharge Alarm does not disable the compressor.

Alarm 4 - Compressor Alarms

Alarm 4 is used to monitor the status of the compressor alarms. Alarm 4 LO indicates the presence of a compressor fault. Alarm 4 HI indicates the presence of a Compressor Lockout.

Alarm 4 - Compressor Fault (LO)

The status of the Compressor Fault contacts across input 6 are monitored when compressor 1 or 2 is ON and when Compressor Fault Enable is yes. If a Low Input 6 Fault is detected for a Compressor Fault Delay [Default 20 s] , then the control will

- 1) set Alarm 4, LO, Compressor Fault
- 2) turn off the Compressor on Compressor Fault Alarm.
- 3) Increment the Compressor Fault Counter
- 4) wait for a Compressor Retry Wait, and then
- 5) try again

If the Compressor fault is still in place at the end of the Compressor Retry Timer, it does not clear the fault alarm and does not re-enable the compressor until the fault clears.⁴

Alarm 4 - Compressor Lockout (HI)

If Compressor Fault Lockout is enabled when the Compressor Fault Alarm appears, the controller will

⁴ Fixed in FW355A 2.0. In earlier versions the compressor would continue to cycle.

January 1999

- 1) turn off the Compressor on Compressor Fault Alarm.
- 2) Increment the Compressor Fault Counter
- 3) wait for a Compressor Retry Wait, and then
- 4) try again incrementing the Compressor Try Counter

If another Compressor Fault Alarm occurs before the end of the Compressor Minimum On Time another attempt is made to Start the compressor, as described above, until the maximum allowed tries, Compressor Try Max [Default, 3] has been exceeded.

When the Compressor Try Counter exceeds the Compressor Try Max [Default, 3], then a Compressor Lockout Alarm is set and no further attempt is made to start the compressor.

The Compressor Lockout Alarm is cleared only by a message, MT=10h, M1=14, or resetting power to the unit.

If the Compressor runs successfully for the Compressor Minimum On Time, the Compressor Try Counter is cleared.

Alarm 5 - Proof of Fan Alarms

A Proof of Fan Switch across Input 7 (Water loop) Opens on proof of fan.⁵ If Proof of Fan Enable is Yes, the switch is examined whenever the fan, or high fan is on, or in Heating with Gas Heat Enable = Yes.

Proof of Fan Status is set when proof of fan established. A Proof of Fan Alarm is set on start when proof of fan fails after a Proof of Fan Delay, or once the fan is running if proof of fan is lost for a Proof of Fan Delay.

Note: The Proof of Fan Alarm is for indication only. No control action results from the proof of fan alarm.

Communications

The ASIC/1-8355 communicates at 1200 baud, 9600 baud, or 19,200 baud on the remote bus using RS-485 twisted pair communication wire, connected to remote screw terminal connector, TB-4. Access to the ASI communication bus is through a SINC/2-2000 system interface which can also be used to broadcast time to synchronize the network of ASIC/1 controllers.

Communication with the remote bus can also be established through the WS-0XX wall sensor using a SINC/1-1030 Portable Interface connected to a lap-top computer running ASI SET8355 Setup Software. It can also communicate through the WT-0XX in the remote communication mode. *The local communication mode is not supported.* Make sure that the Amber Local LED on the SINC/1-1030 is Off.

Each controller has a unique 16 bit address, and may also have a separate 8 bit group address. It will also respond to the global addresses 23125 (5A55h) and 23130 (5A5Ah), and the device global address 23093 (5A 35h) in FW355A Rev 1.7

⁵ Proof of fan indication was added with FW355A1.9. There is no control action.

System Component Checklist

Inputs

Description	Part Number	Quantity
Optional Outdoor Air Temperature Sensor (IN-05)	TS-O	0,1
Optional Discharge Air Temperature Sensor (IN-06)	TS-D-8	0,1
Optional Water Loop Temperature Sensor (IN-07)	TS-I-4, or TS-S	0,1
Optional Auxiliary Temperature Sensor (IN-08)	TS-D-8	0,1
Optional Occupancy Switch (BI-08)	MOT Series	0,1
Wall Mounted Zone Temperature Sensor	WS-0XX	1
Sensor Cable	SCP-0XX	1
Communication Cable twisted pair.	22-24 ga twisted	
ASIC/1-8x55 Enclosure Cover Kit	CE-055	0,1

NOTE: Consult ASIC/1-8X55 Installation manual for configuration of inputs.

Outputs

Description	Part Number	Quantity
Packaged AC Controller	ASIC/1-8355	1
24 Vac Transformer		1
24 Vac Fan Control Relay with line voltage contacts	TRB-5AC(1)	1,2
24 Vac Compressor Relay with line voltage contacts	TRB-5AC(2,3)	0,1,2,
24 Vac Electric Heat Relay with line voltage contacts	TRB-5AC(4,5)	0,1,2,
Economizer Damper with 24 Vac Tri-state Operator		0,1
24 Vac Auxiliary CLG Output Relay (Optional)		0,1
24 Vac Auxiliary HTG Output Relay (Optional)		0,1
24 Vac Auxiliary Output Relay (Optional)		0,1,2,
24 Vac Lighting Relay (Optional)		0,1

NOTE: The ASIC/1-8355 must be connected to a solid building ground. Metallic-oxide Varistors, MOV, may also be used across relay contacts to provide further protection from transients. If current interrupting relays are in series with the output circuits they must be protected with MOVs across the Relay Contacts

Wiring Layout

Typical Packaged AC Unit with 2 Stages of Air Conditioning and 2 Stages of Heat.

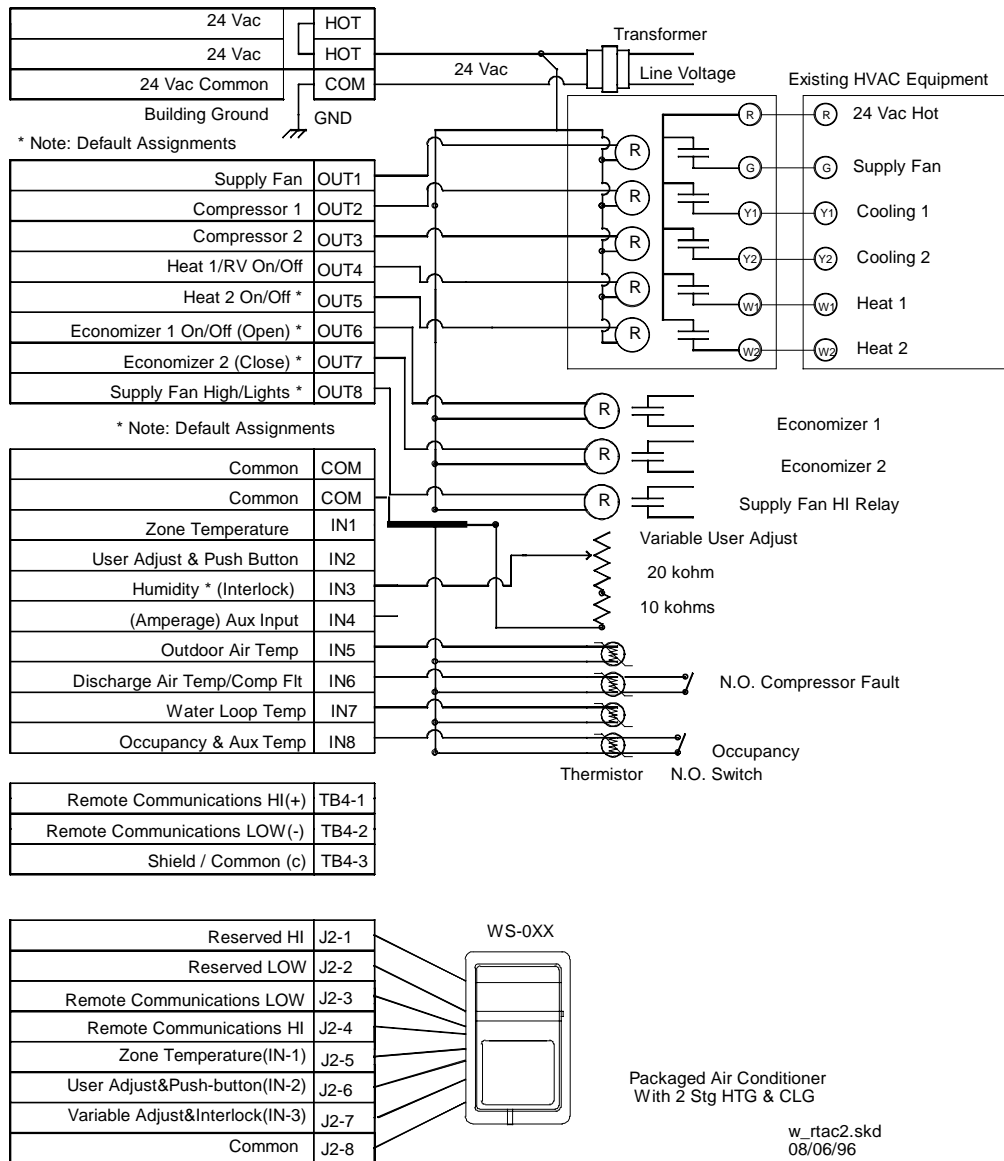

NOTE: Interposing relays such as the Triac Relay Board TRB-5AC must be used between the control outputs on the ASIC/1-8355 and the line voltage contactors.